

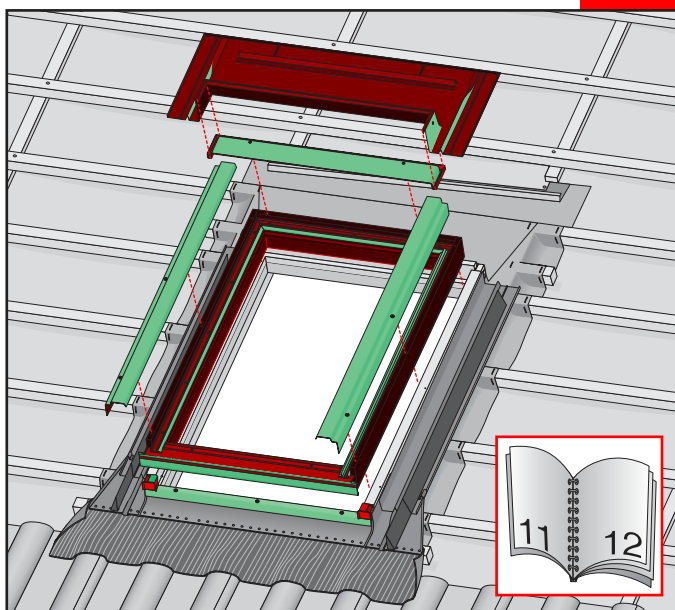

# FNP

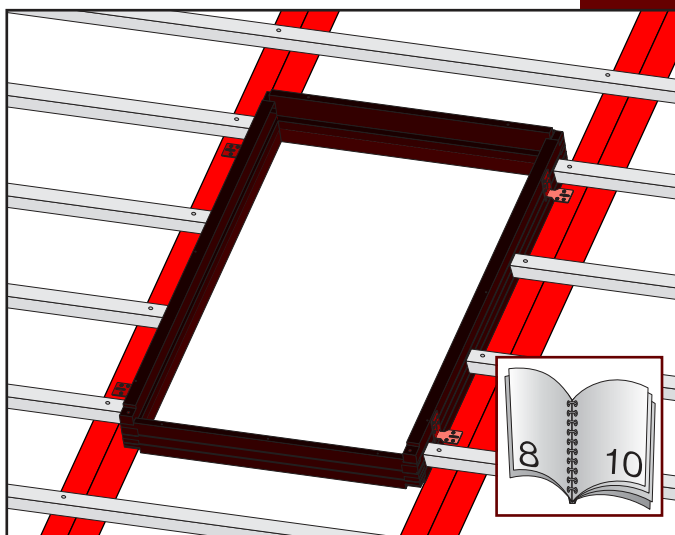

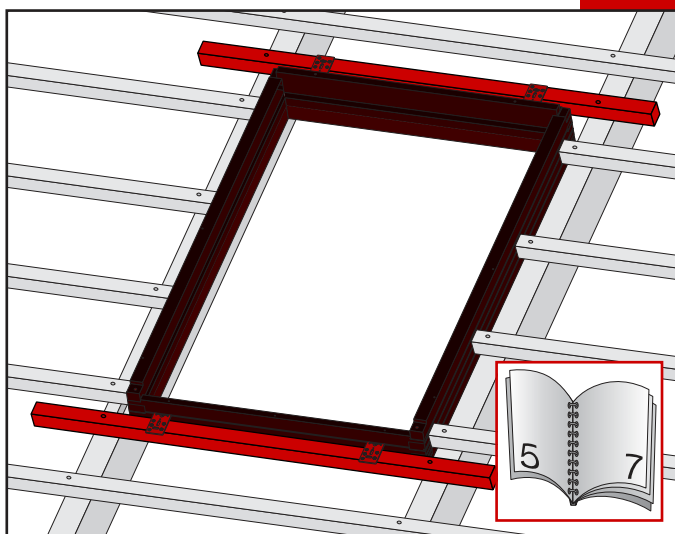
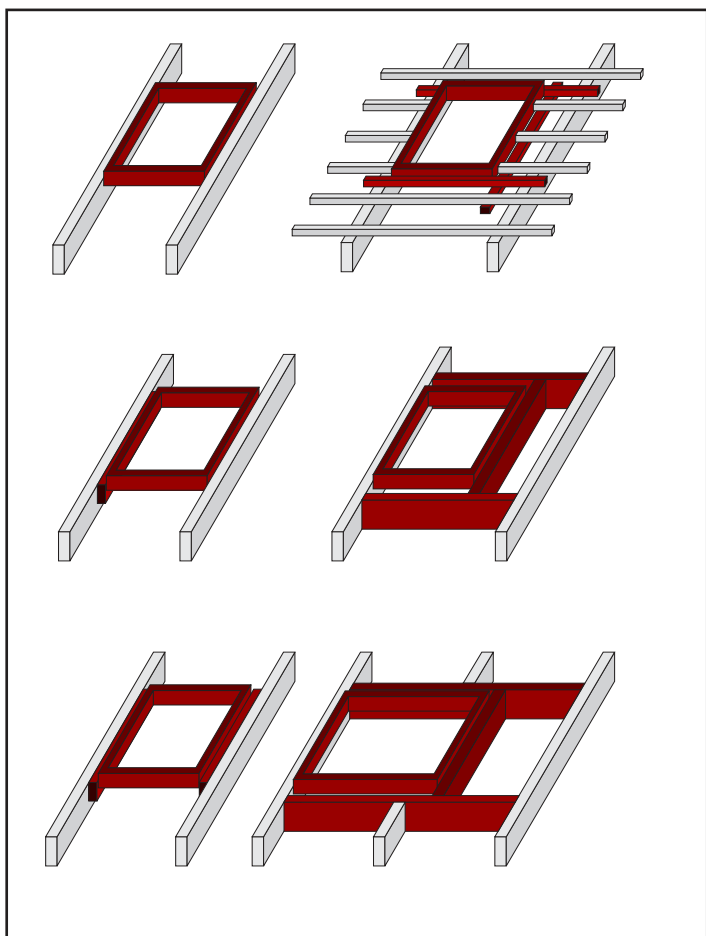
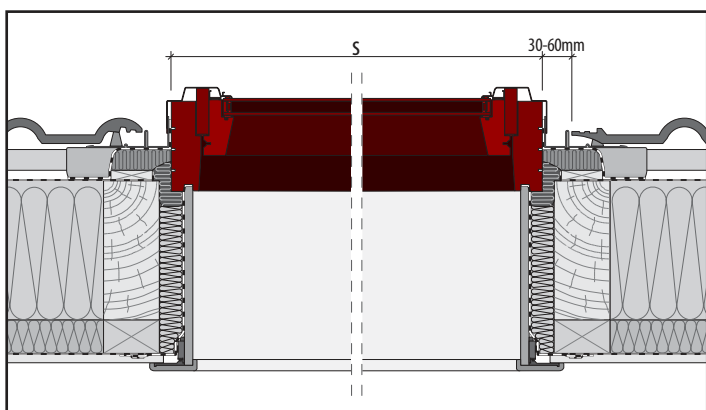
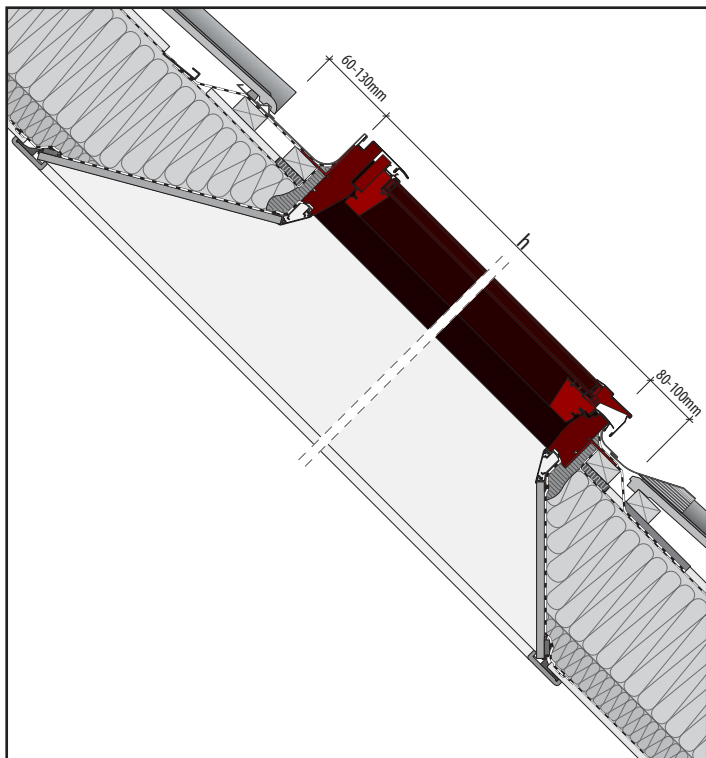
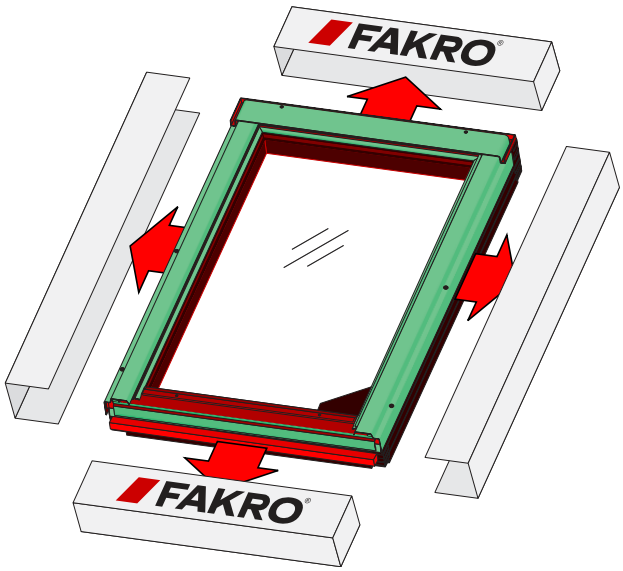
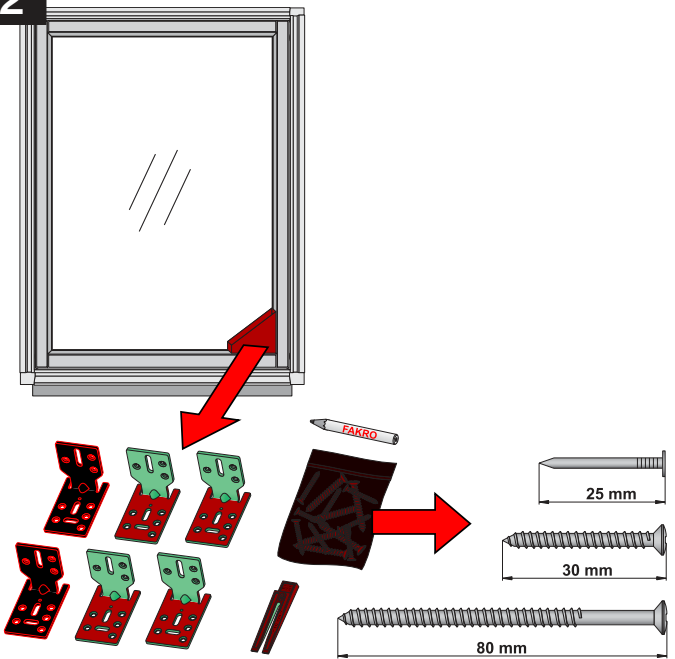
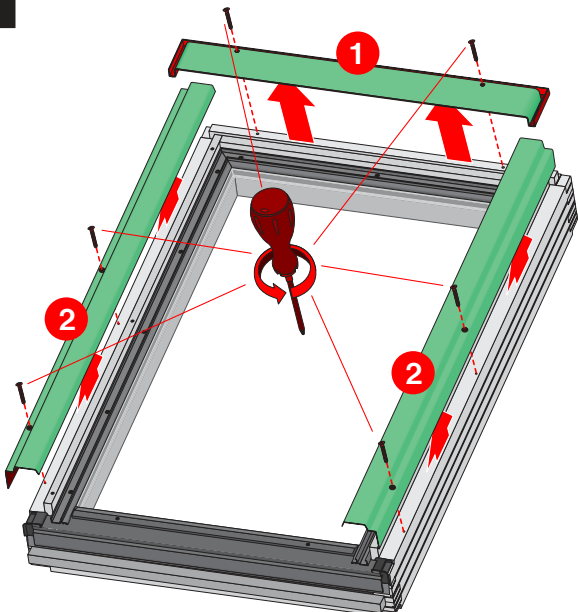

**1****2****3**

4

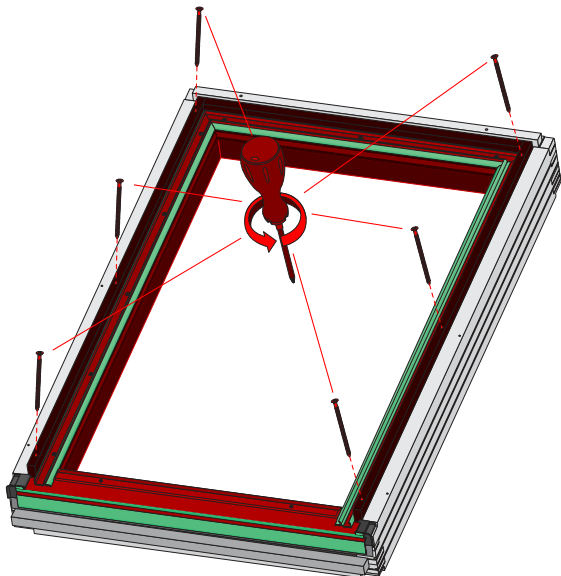
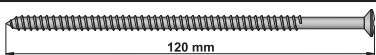

5

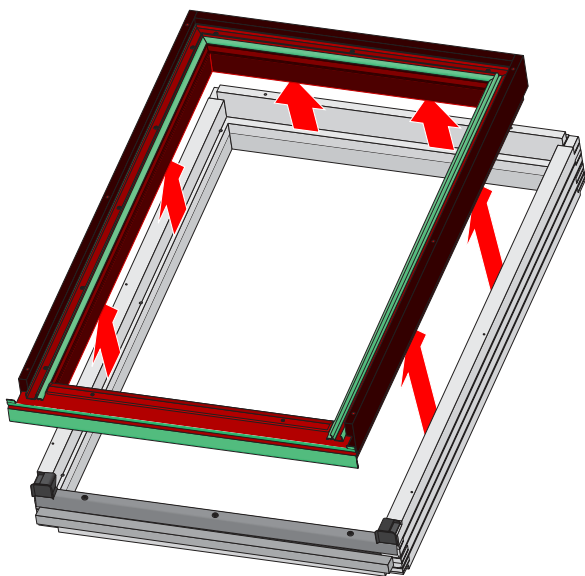

6

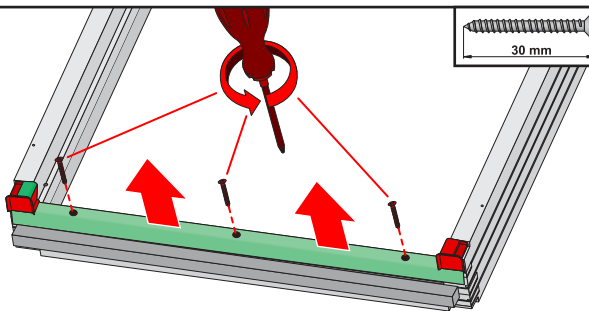
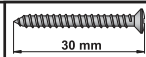

7

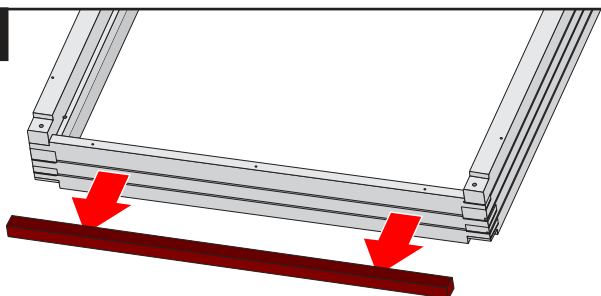

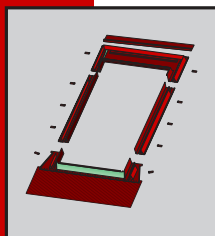
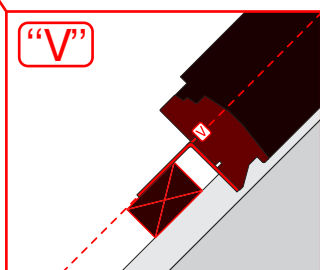
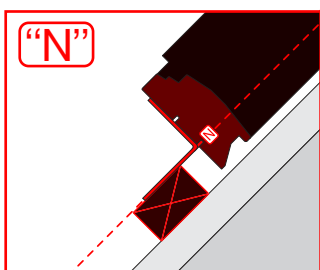
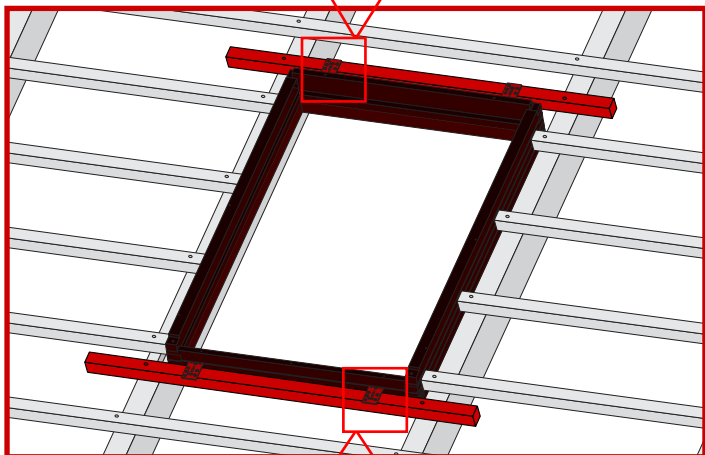
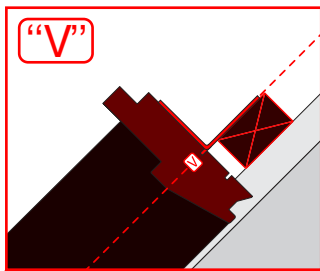
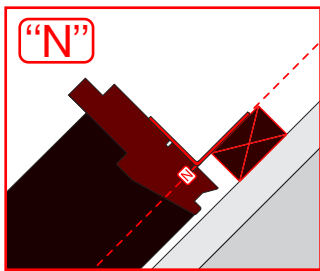

max 90mm



**EHN**



**EHV**



-

-

-

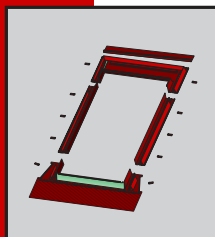

max 45mm

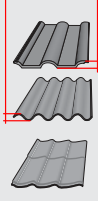

**EZN**

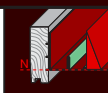

**EZV**



-

-

-

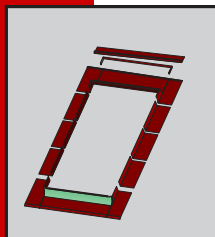

max 15mm (N)  
max 5mm (V)

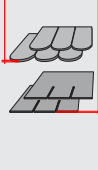

**ELN**

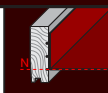

**ELV**

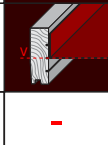

-

-

-

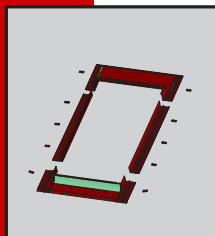

max 5mm

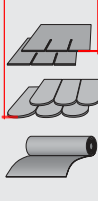

**ESN**

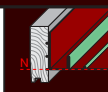

**ESV**

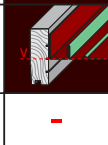

-

-

-

1

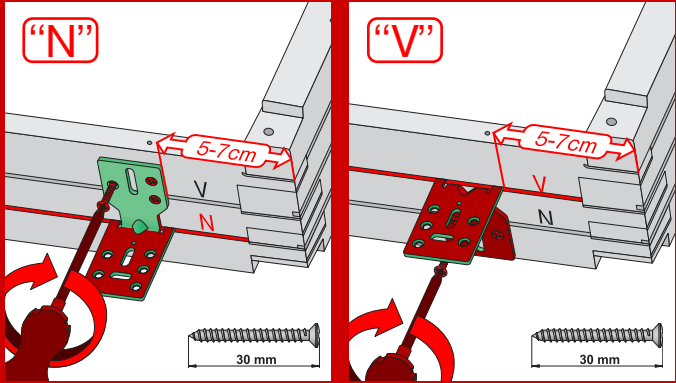

2

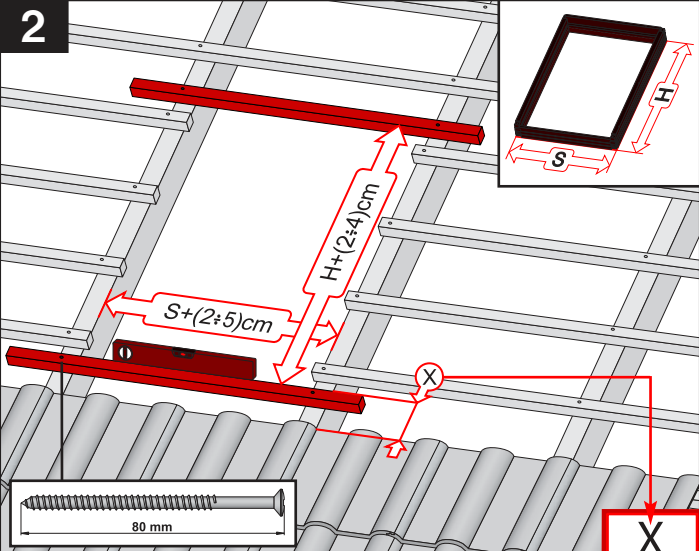

	max 90mm	EHN EHV	7-10cm 7-10cm
	max 45mm	EZN EZV	6-8cm 6-8cm
	12-16mm	EGV	4cm
	12-16mm	EPV	6cm
	max 5mm (V) max 15mm (N)	ELN ELV	0-2cm 0-2cm
		EEN EEV	0-2cm 0-2cm

3

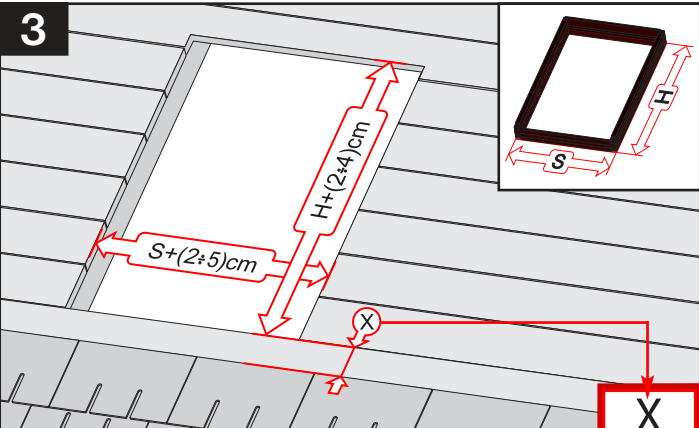

	max 5mm	ESN ESV	0-2cm 0-2cm
--	---------	------------	----------------



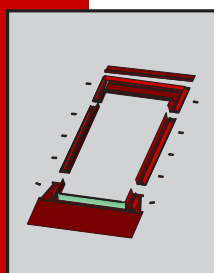
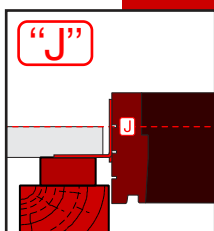
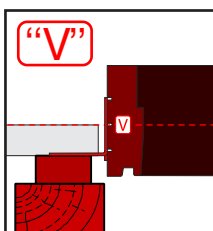
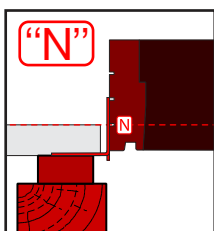
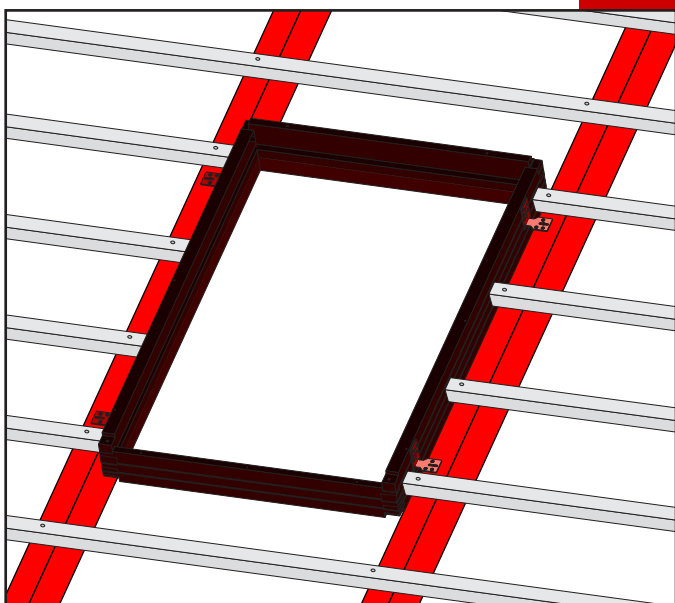

max 90mm



**EHN**

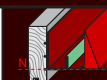

**EHV**



-

-

-

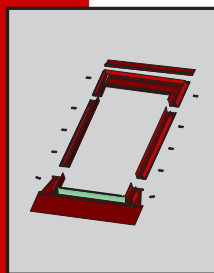

max 45mm

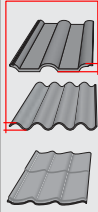

**EZN**



**EZV**



**EZJ**

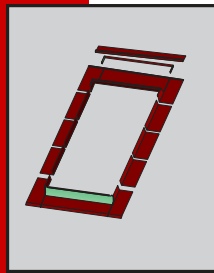

max 15mm (N)  
max 5mm (V)  
max 5mm (J)

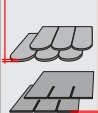

**ELN**

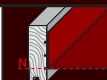

**ELV**



**ELJ**

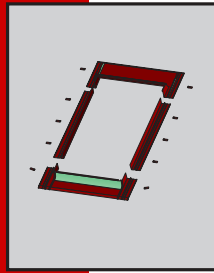

max 5mm

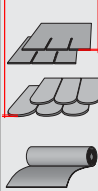

**ESN**



**ESV**

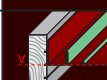

**ESJ**





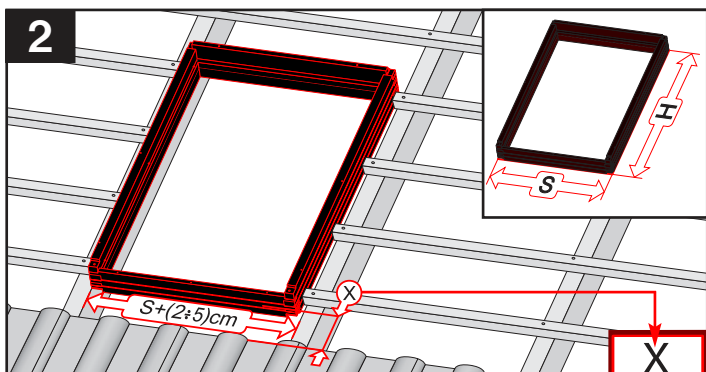
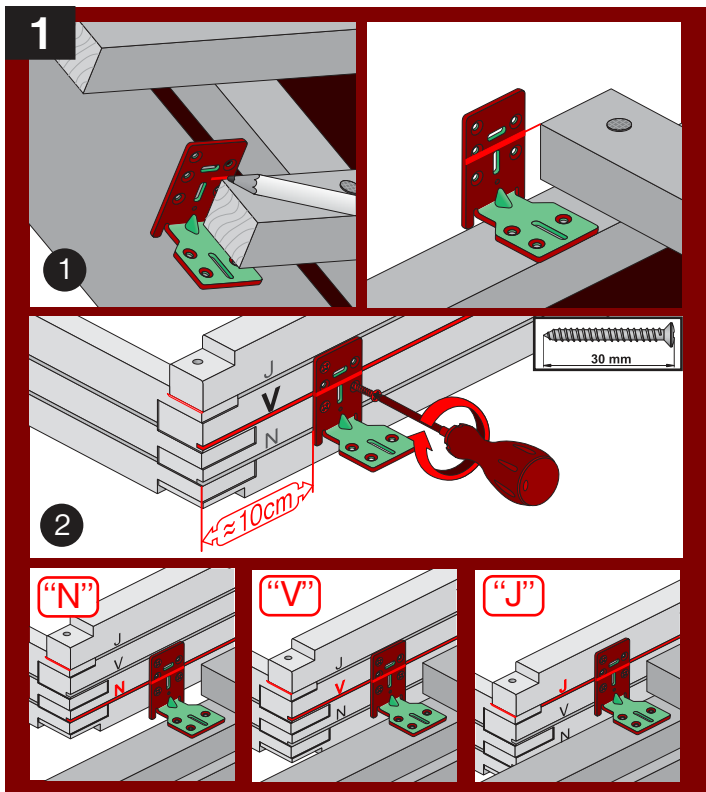

		X
	max 90mm	EHN 9-12cm EHV 9-12cm
	max 45mm	EZN 8-10cm EZV 8-10cm EZJ 20cm
	380-420mm, 12-16mm	EGV 6cm
	250-280mm, max 18mm	EPV 8cm
	max 5mm (V,J) max 15mm (N)	ELN 0-4cm ELV 0-4cm ELJ 11cm
		EEN 0-4cm EEV 0-4cm EEJ 11cm

		X
	max 5mm	ESN 0-4cm ESV 0-4cm ESJ 11cm

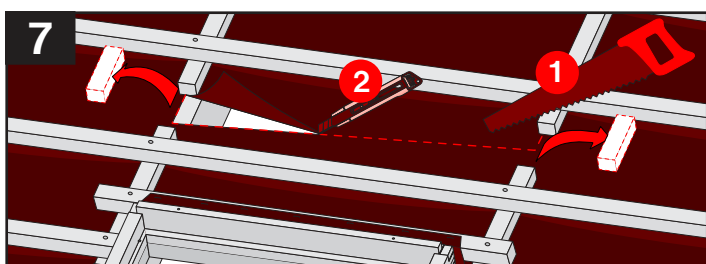
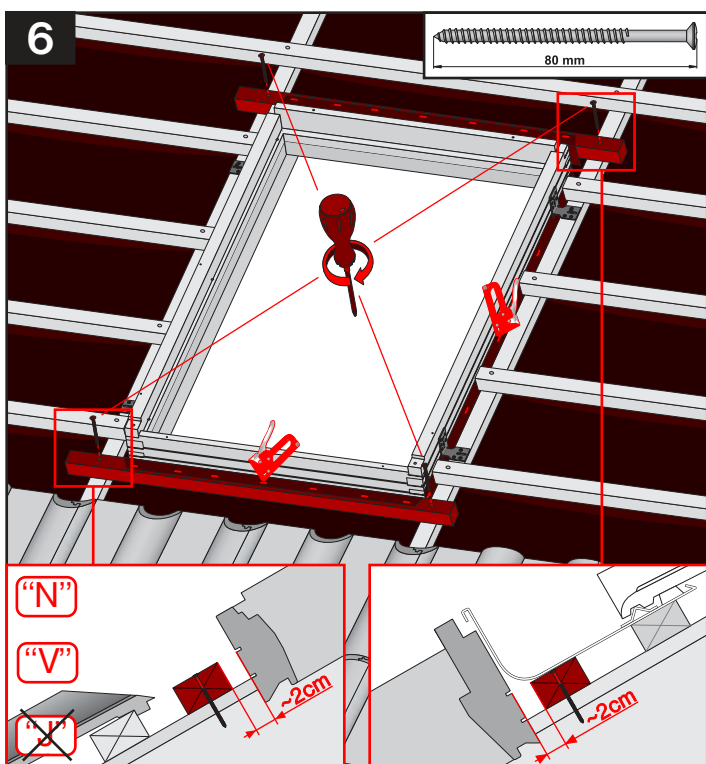
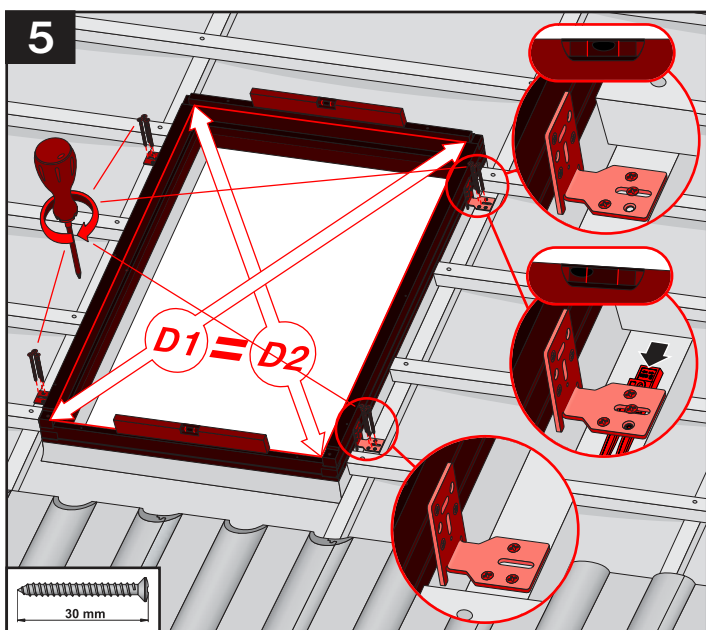
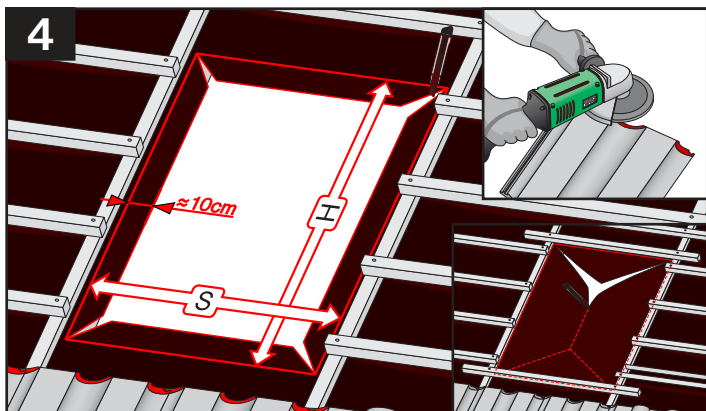

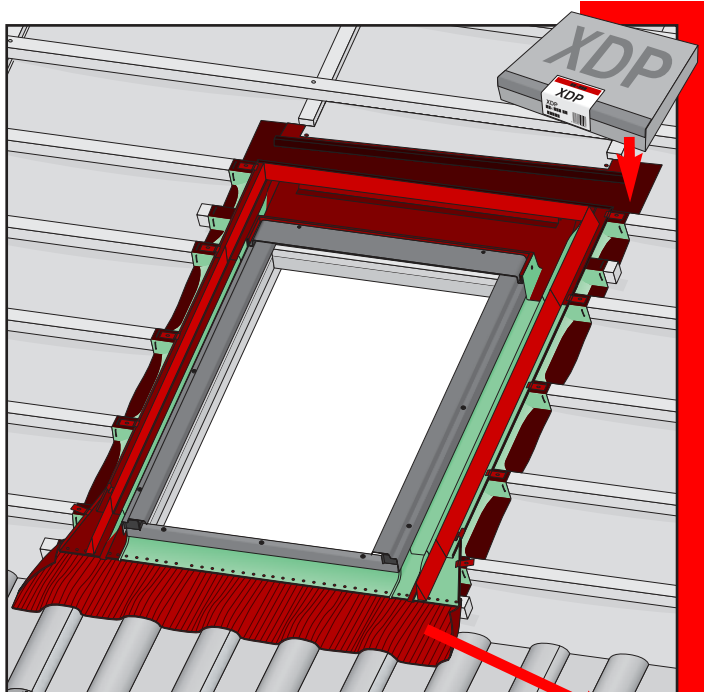

	<p>max 90mm</p>	<p>EHN EHV</p>
	<p>max 45mm</p>	<p>EZN EZV EZJ</p>
	<p>max 5mm</p>	<p>ESN ESV ESJ</p>
	<p>380-420mm</p> <p>12-16mm</p>	<p>EGV</p>
	<p>250-280mm</p> <p>max 18mm</p>	<p>EPV</p>
	<p>max 5mm (V,J) max 15mm (N)</p>	<p>ELN ELV ELJ</p>
		<p>EEN EEV EEJ</p>

