

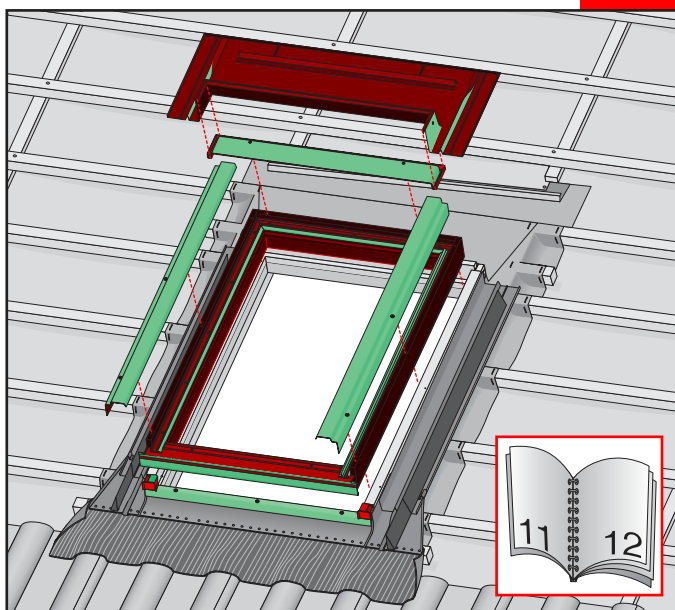

FNP

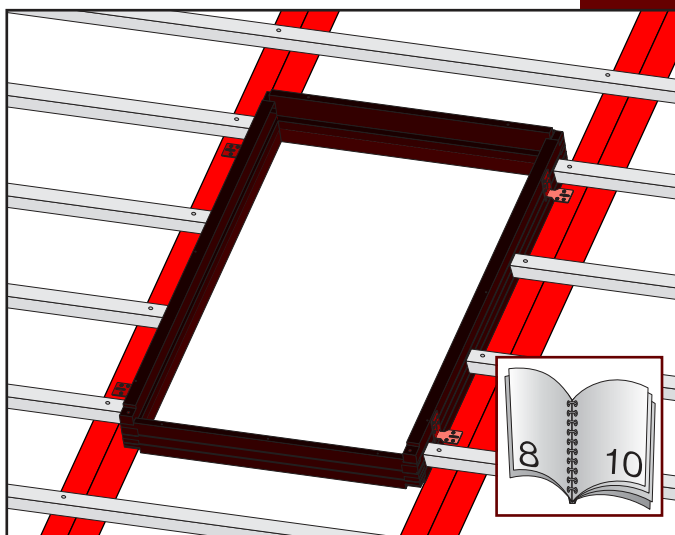

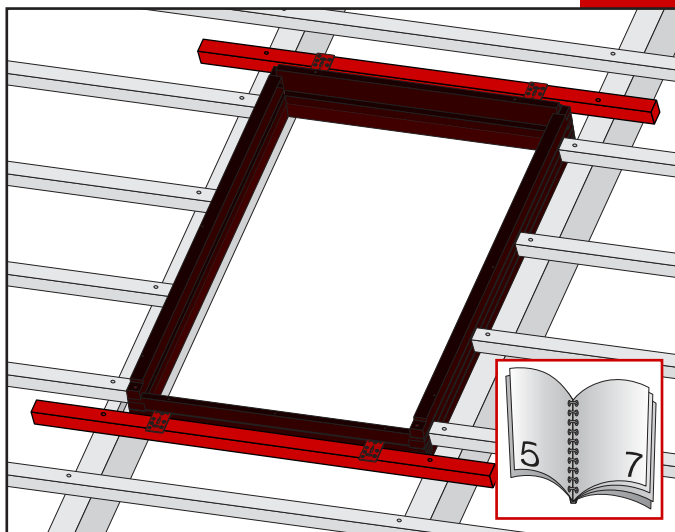
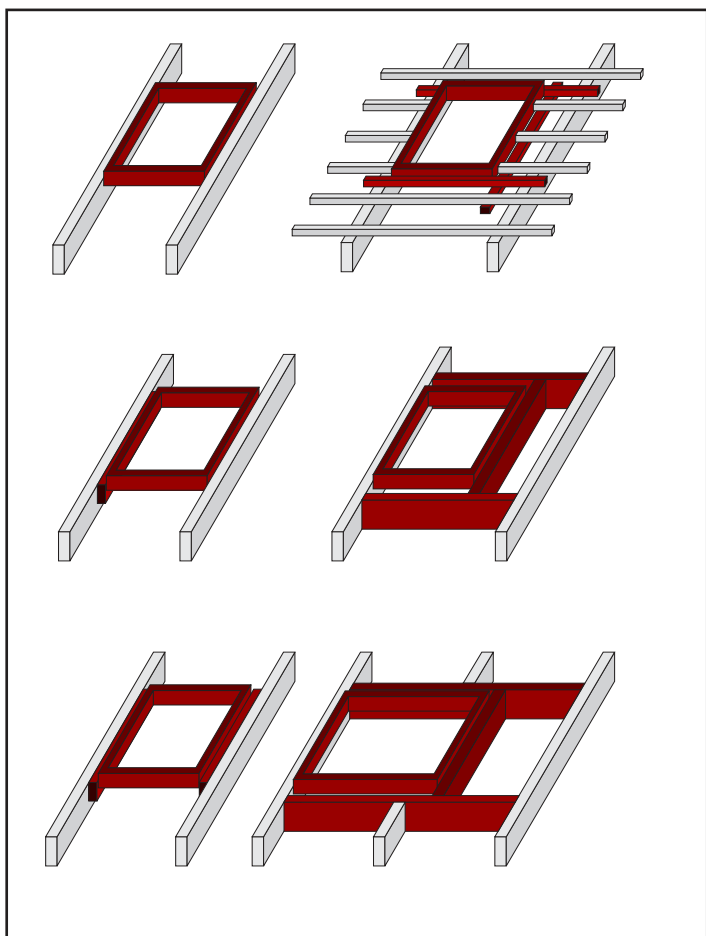
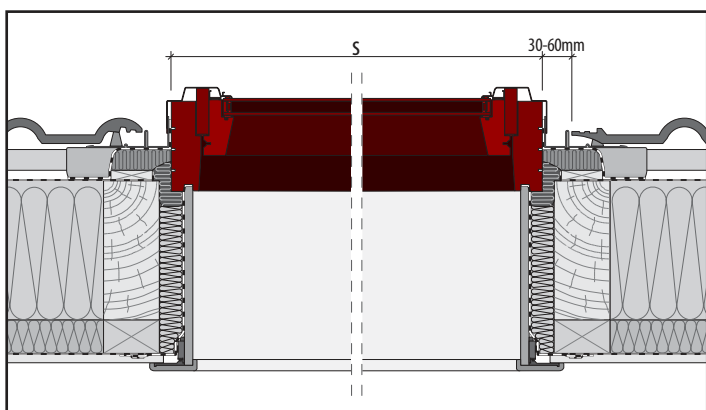
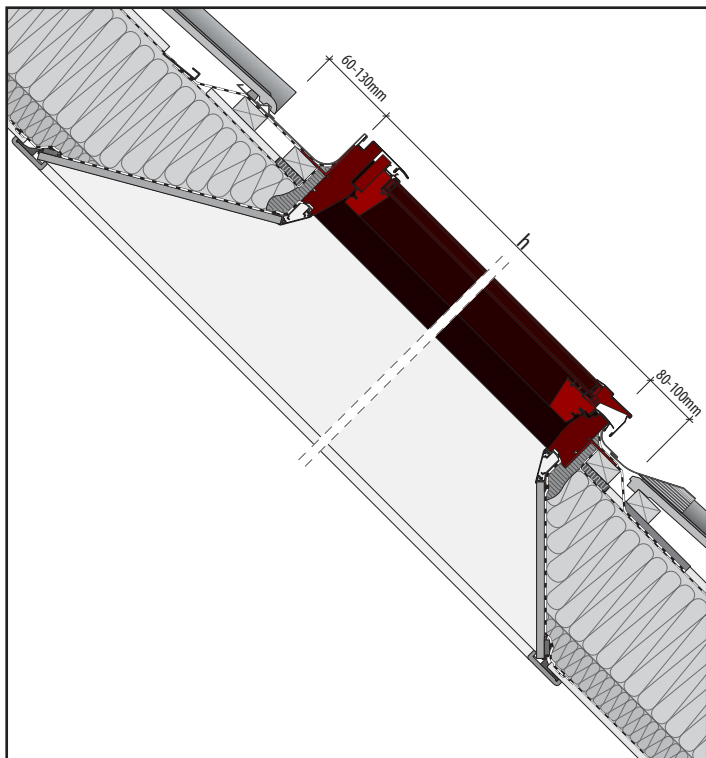
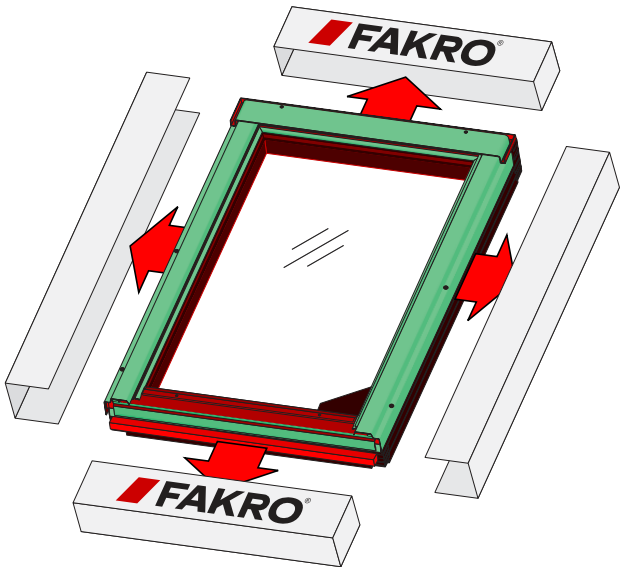
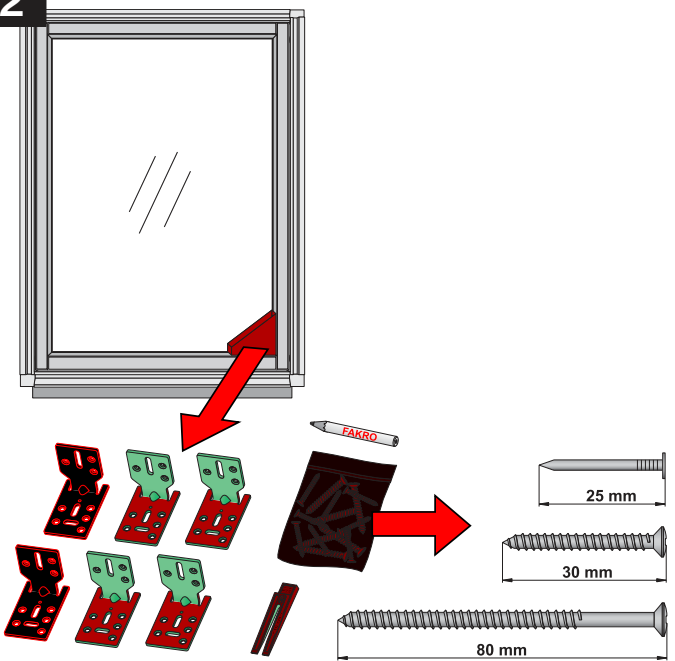
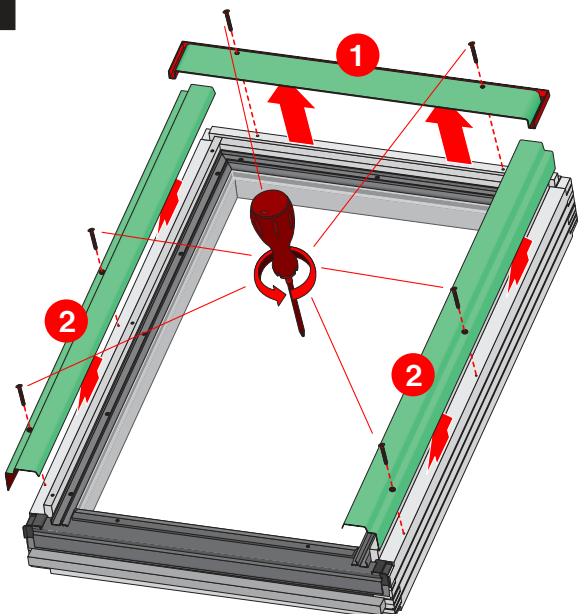

1**2****3**

4

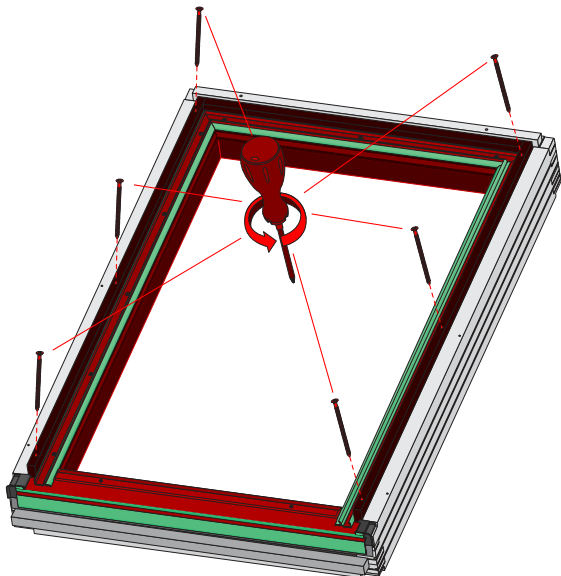
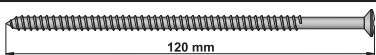

5

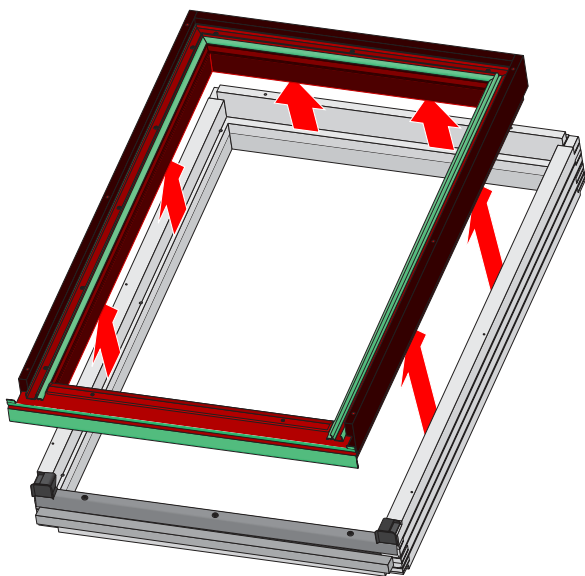

6

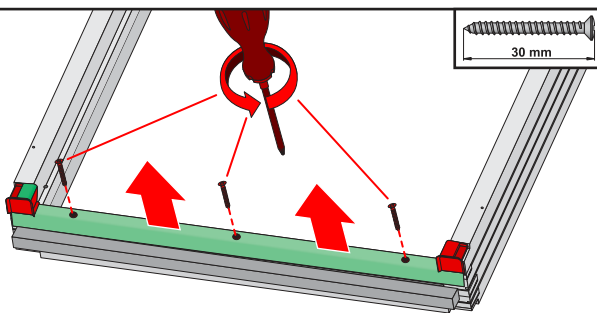

7

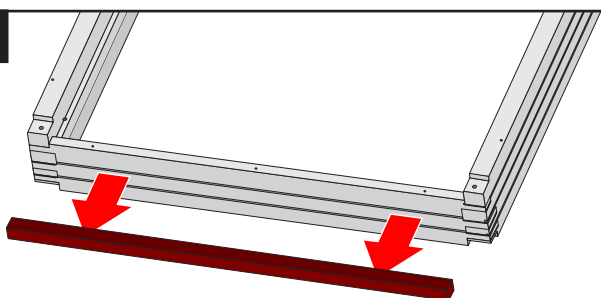

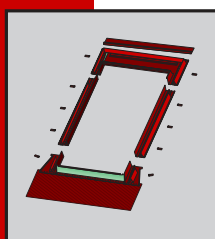
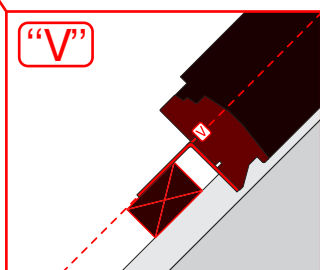
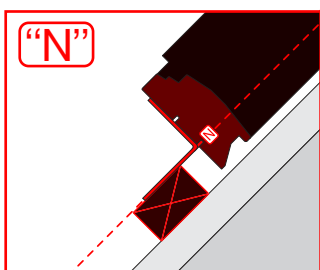
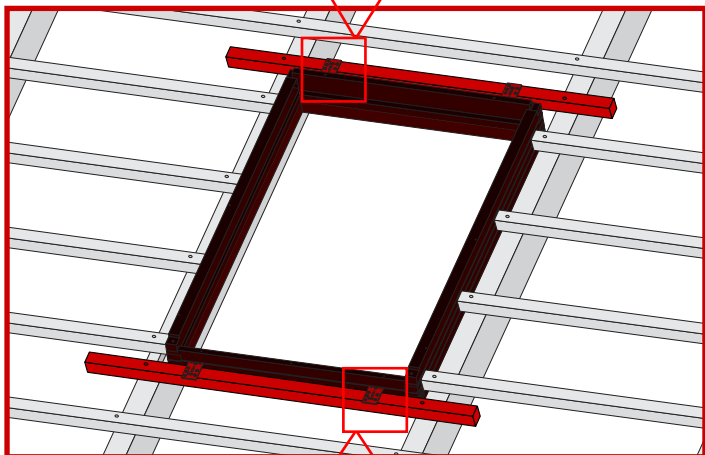
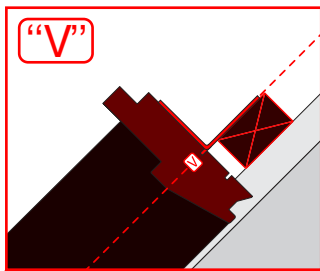
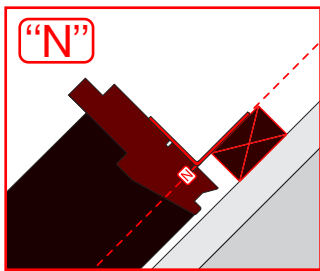

max 90mm



EHN

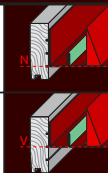

EHV

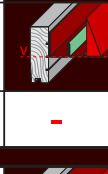

-

-

-

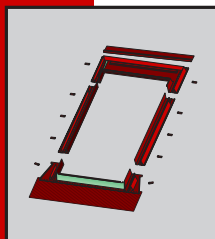

max 45mm

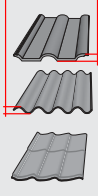

EZN



EZV

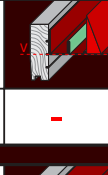

-

-

-

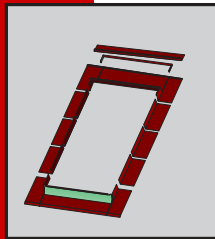

max 15mm (N)
max 5mm (V)

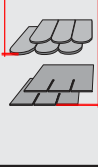

ELN

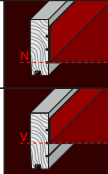

ELV

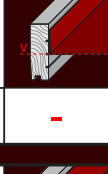

-

-

-

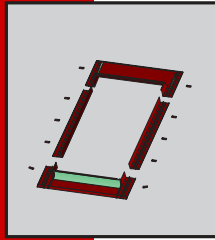

max 5mm

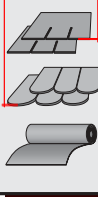

ESN

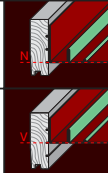

ESV

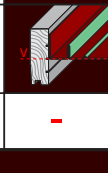

-

-

-

1

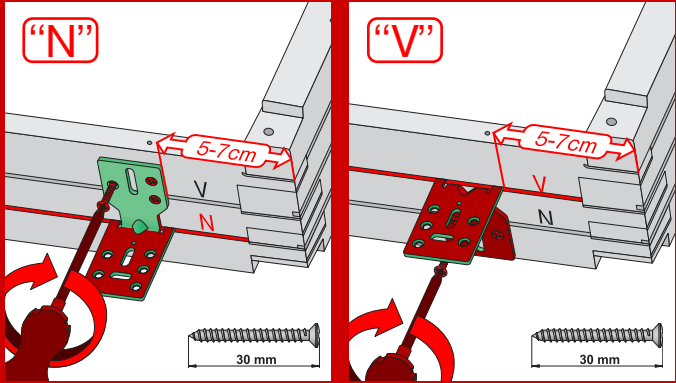

2

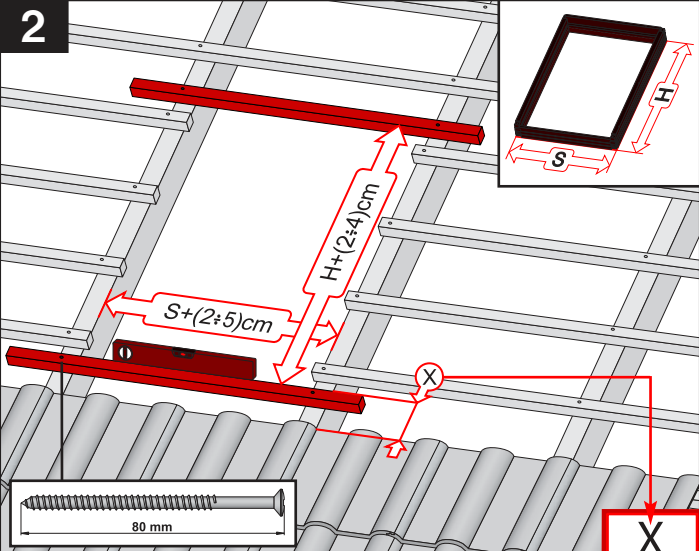

		X	
		max 90mm	EHN 7-10cm EHV 7-10cm
		max 45mm	EZN 6-8cm EZV 6-8cm
		12-16mm	EGV 4cm EPV 6cm
		max 5mm (V) max 15mm (N)	ELN 0-2cm ELV 0-2cm
			EEN 0-2cm EEV 0-2cm

3

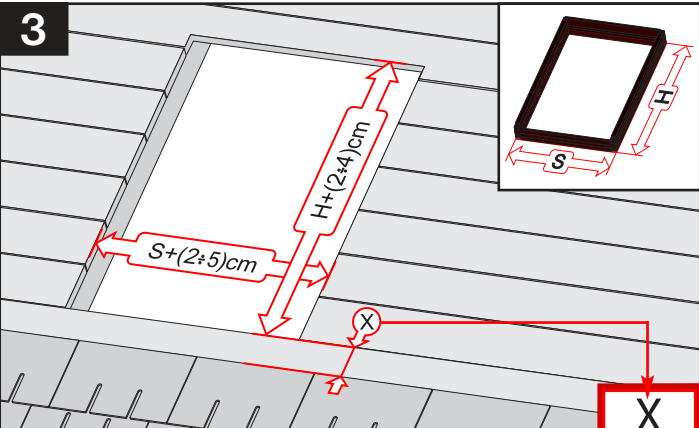

		X	
		max 5mm	ESN 0-2cm ESV 0-2cm

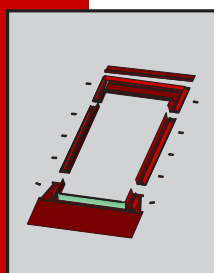
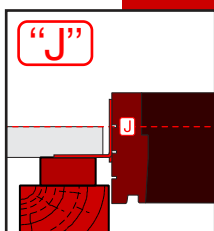
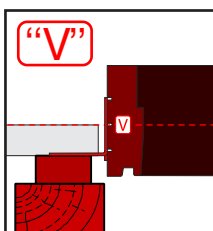
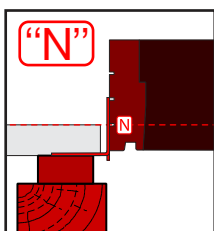
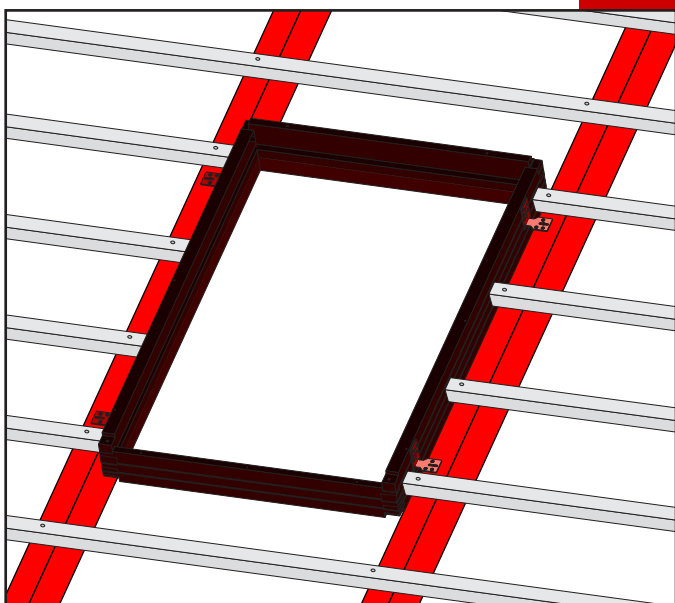

max 90mm



EHN

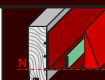

EHV



-

-

-

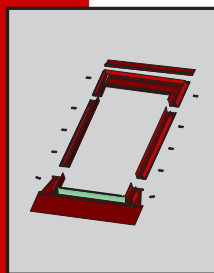

max 45mm

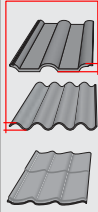

EZN

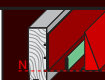

EZV



EZJ

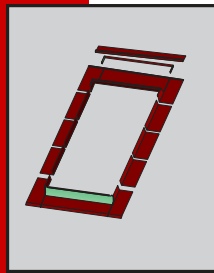

max 15mm (N)
max 5mm (V)
max 5mm (J)

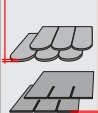

ELN

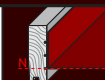

ELV



ELJ

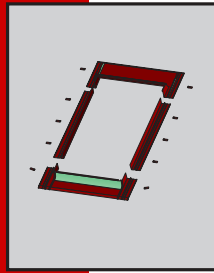
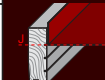

max 5mm

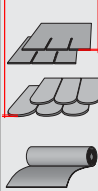

ESN

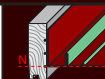

ESV

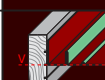

ESJ



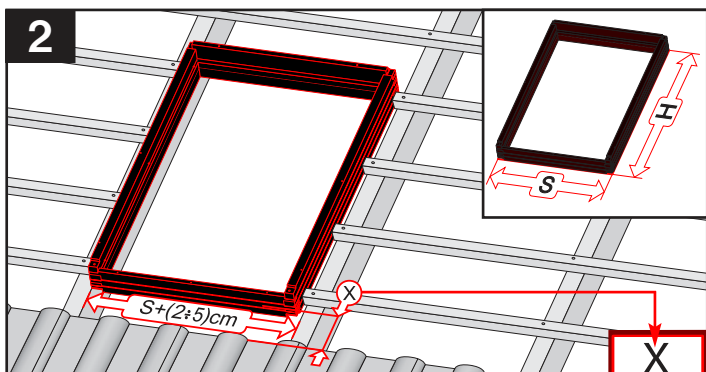
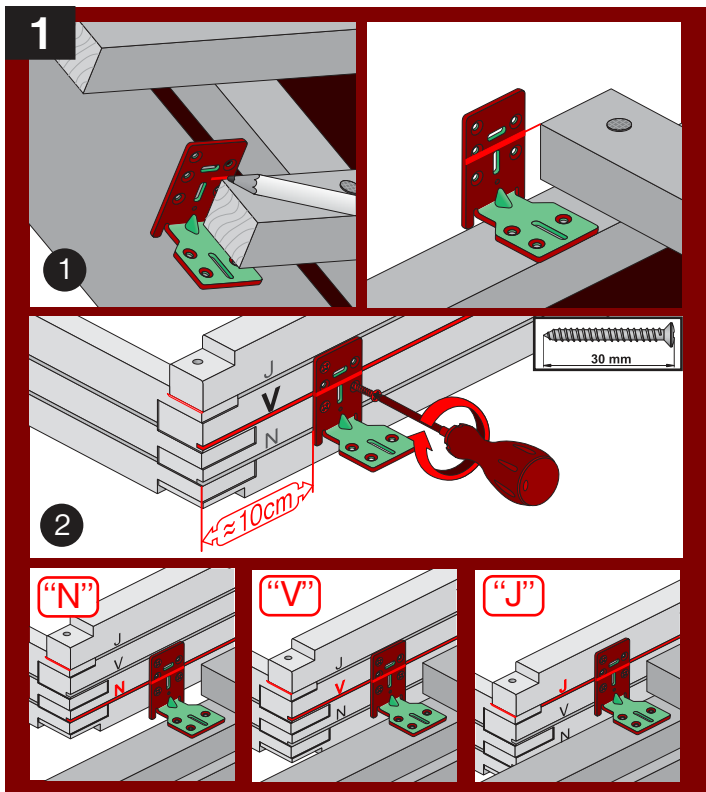

		X
	max 90mm	EHN 9-12cm EHV 9-12cm
	max 45mm	EZN 8-10cm EZV 8-10cm EZJ 20cm
	380-420mm, 12-16mm	EGV 6cm
	250-280mm, max 18mm	EPV 8cm
	max 5mm (V,J) max 15mm (N)	ELN 0-4cm ELV 0-4cm ELJ 11cm
		EEN 0-4cm EEV 0-4cm EEJ 11cm

		X
	max 5mm	ESN 0-4cm ESV 0-4cm ESJ 11cm

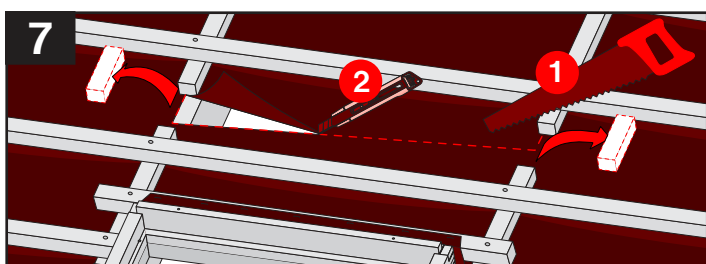
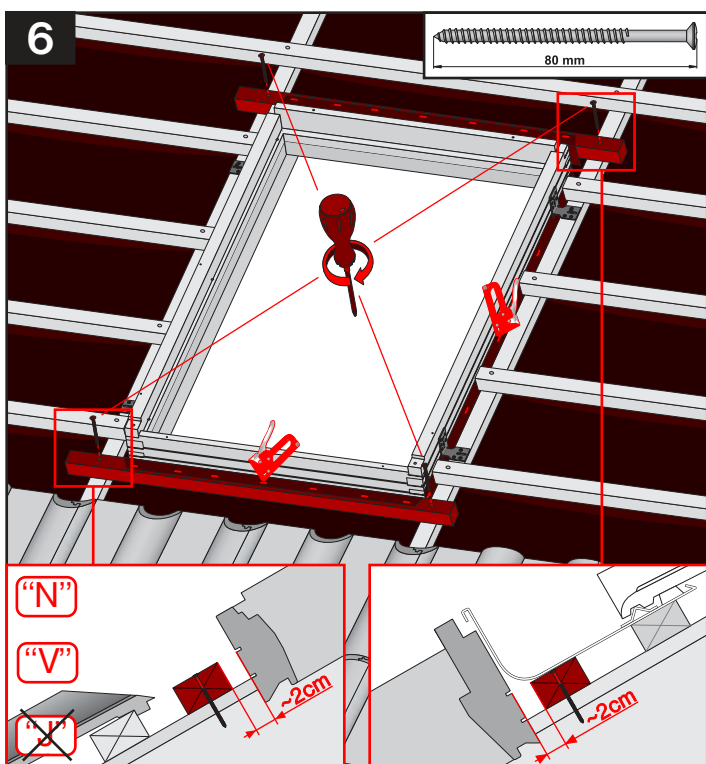
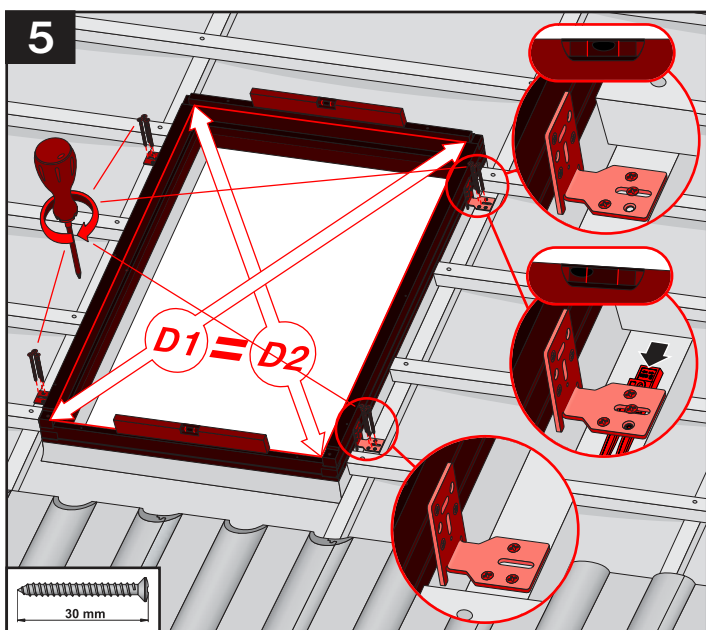
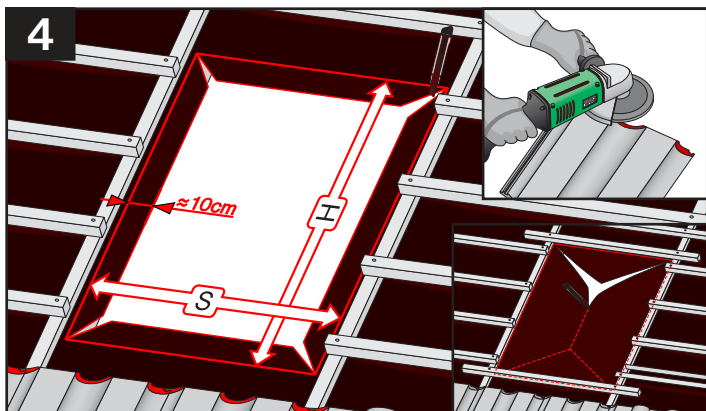

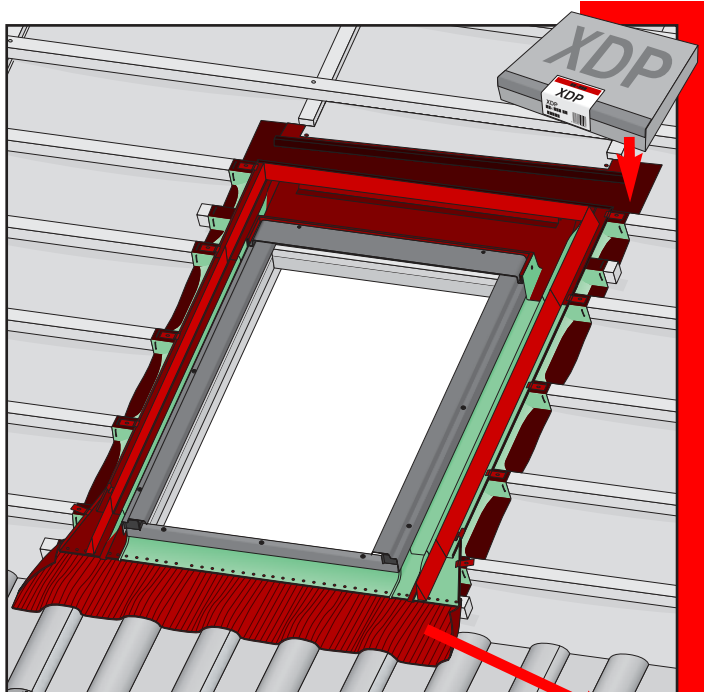

	<p>max 90mm</p>	<p>EHN EHV</p>
	<p>max 45mm</p>	<p>EZN EZV EZJ</p>
	<p>max 5mm</p>	<p>ESN ESV ESJ</p>
<p>380-420mm</p>	<p>12-16mm</p>	<p>EGV</p>
<p>250-280mm</p>	<p>max 18mm</p>	<p>EPV</p>
	<p>max 5mm (V,J) max 15mm (N)</p>	<p>ELN ELV ELJ</p>
		<p>EEN EEV EEJ</p>

